

DUKANE

Model 28A7100HC



User's Guide

EMC Directive 89/336/EEC, Amended by 93/68/EEC

EMC: EN 55022

EN 55024

EN 61000-3-2

EN 61000-3-3

Low Voltage Directive 73/23/EEC, Amended by 93/68/EEC

Safety: EN 60950: 2000

November, 2002

Australian Certification C-tick mark

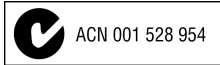

Trademarks

Apple, Macintosh, and PowerBook are trademarks or registered trademarks of Apple Computer, Inc. IBM and PS/2 are trademarks or registered trademarks of International Business Machines, Inc. Microsoft, PowerPoint, and Windows are trademarks or registered trademarks of Microsoft Corporation. InFocus and LP are trademarks or registered trademarks of InFocus Corporation.

FCC Warning

Note: This equipment has been tested and found to comply with the limits for a Class B digital device, pursuant to part 15 of the FCC Rules. These limits are designed to provide reasonable protection against harmful interference in a residential installation. This equipment generates, uses and can radiate radio frequency energy and, if not installed and used in accordance with the instructions, may cause harmful interference to radio communications. However, there is no guarantee that interference will not occur in a particular installation. If this equipment does cause harmful interference to radio or television reception, which can be determined by turning the equipment off and on, the user is encouraged to try to correct the interference by one or more of the following measures:

- Reorient or relocate the receiving antenna.
- Increase the separation between the equipment and receiver.
- Connect the equipment into an outlet on a circuit different from that to which the receiver is connected.
- Consult the dealer or an experienced radio/TV technician for help.

Canada

This Class B digital apparatus complies with Canadian ICES-003.

Cet appareil numérique de la classe B est conforme à la norme NMB-003 du Canada.

Safety Certifications

UL, c-UL, TÜV, NOM, IRAM, GOST

Table of Contents

Introduction	4
Positioning the projector	5
Connecting a computer source	6
Required computer connections	6
Optional computer connections	6
Displaying a computer source image	7
Adjusting the image	8
Using the projector with Windows 98 for the first time	9
Connecting a video device	11
Video connections	12
Video device connections	13
Composite video connection	13
S-video connection	13
Component video connection	14
VGA connection	14
Displaying video	15
Adjusting the image	15
Shutting down the projector	17
Troubleshooting your setup	17
Using the remote control	25
Using the audio	26
Using the keypad buttons	26
Optimizing computer images	27
Presentation features	27
Optimizing video images	28
Customizing the projector	28
Using the menus	29
Picture menu	30
Settings menu	33
Maintenance	36
Cleaning the Lens	36
Replacing the Projection Lamp	36
Cleaning the Lamp Housing Screens	38
Using the security lock	38
Appendix	39
Specifications	39
Projected image size	40
Red LED Behavior and Projector Errors	41

If you are experienced in setting up projection systems, use the *Quick Setup* card that was included. For complete details on connecting and operating the projector, refer to this User's Guide.

The website also has technical specifications (an interactive image size calculator, laptop activation commands, connector pin outs, a glossary, the product data sheet), a web store to buy accessories, and a page for online registration.

Important Operating Considerations

Do not place the projector on a tablecloth or other soft coverings that may block the front or back vents. Do not use a non-approved ceiling mount. In the unlikely event of the bulb rupturing, thoroughly clean the area in front of the projector and discard any edible items that may have been placed in that area.

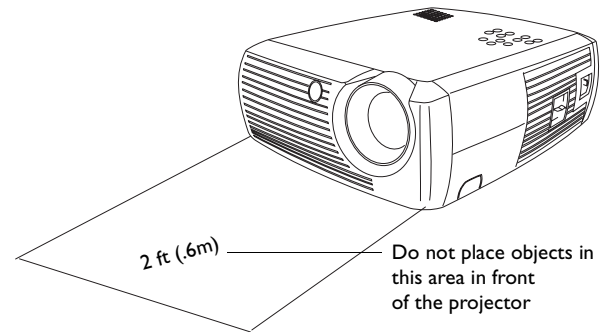

Introduction

Your new digital projector is easy to connect, use, and maintain. It is an exceptional projector for both business presentations and home entertainment. Dukane 28A7100HC is compatible with a wide variety of computers and video devices, including:

- Most standard VCRs, DVD players (progressive and interlaced), HDTV sources (1080i, 1035i, and 720P HDTV formats), TV and satellite tuners, camcorders, video games, and laser disc players.
- IBM-compatible computers, including laptops, up to 1024x768 resolution.
- Apple® Macintosh® and PowerBook® computers up to 1024x768 resolution.

The projector has native SVGA 800x600 resolution and comes with the following standard accessories.

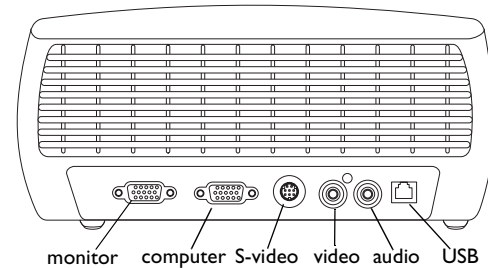
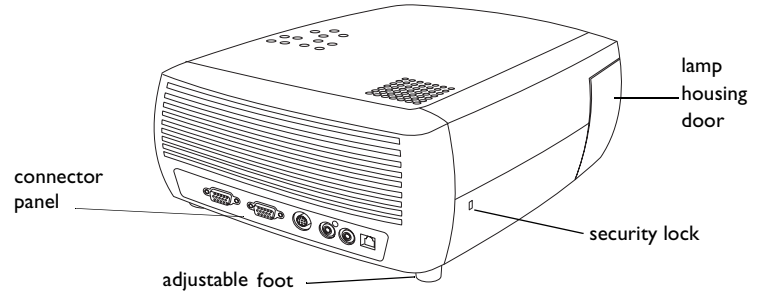
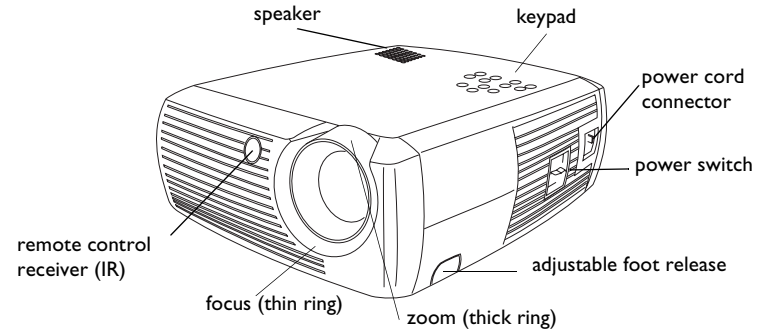
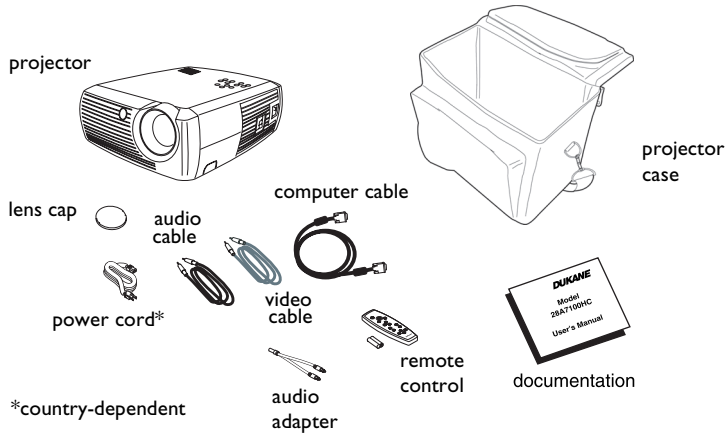

Positioning the projector

To determine where to position the projector, consider the size and shape of your screen, the location of your power outlets, and the distance between the projector and the rest of your equipment. Here are some general guidelines:

- Position the projector on a flat surface at a right angle to the screen. The projector must be at least 4.9 feet (1.49m) from the projection screen.
- Position the projector within 10 feet (3m) of your power source and within 6 feet (1.8m) of your video device (unless you purchase extension cables). To ensure adequate cable access, do not place the projector within 6 inches (.15m) of a wall or other object.
- If you are installing the projector on the ceiling, refer to the installation guide that comes with the Ceiling Mount Kit for more information. To turn the image upside down, see “Ceiling” on page 33.
- Position the projector the desired distance from the screen. The distance from the lens of the projector to the screen, the zoom setting, and the video format determine the size of the projected image. The top illustration to the right shows three projected image sizes. For more information about image sizes at different distances, see “Projected image size” on page 40.
- The image exits the projector at a given angle. The image offset is 112.2% when the projector is in 4:3 mode (default mode). This means that if you have an image 10’ high, the bottom of the image will be 1.22’ above the center of the lens.
- This image offset is 124.7% when the projector is in 16:9 mode. This means that if you have an image 10’ high, the bottom of the image will be 2.47’ above the center of the lens.
- See “Connecting a video device” on page 11 for additional information on 16:9 and 4:3 modes.

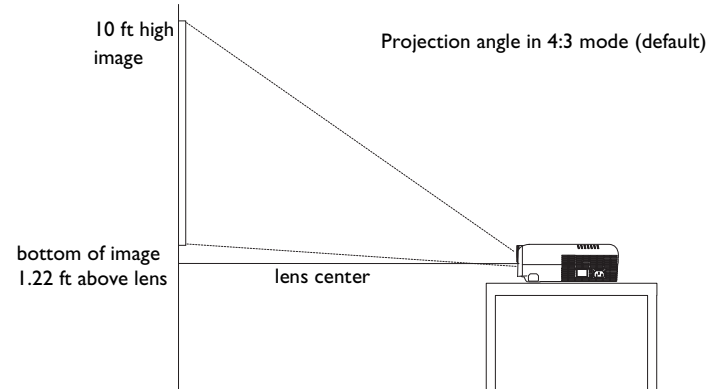
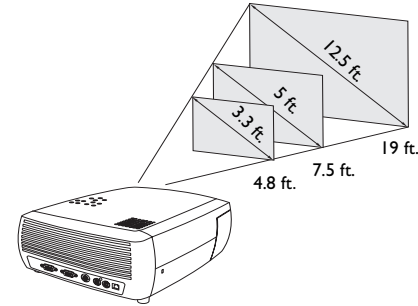

Connecting a computer source

Required computer connections

Connect one end of the computer cable (see page 11 for connecting video devices) to the dark blue **Computer In** connector on the projector. Connect the other end to the video port on your computer. If you are using a desktop computer, you will need to disconnect the monitor cable from the computer's video port first.

Connect the black power cord to the **Power** connector on the side of the projector and to your electrical outlet.

NOTE: Always use the power cord that shipped with the projector.

connect computer cable

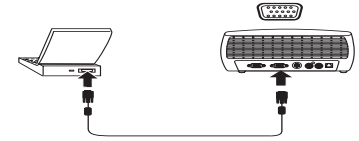

connect power cable

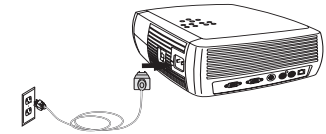

Optional computer connections

To have sound with your presentation, connect the audio cable to your computer and to the **Audio In** connector on the projector.

connect audio cable

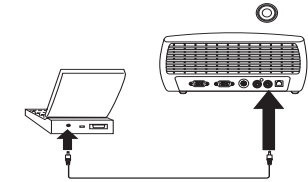

If you are using a desktop computer and want to see the image on your computer screen as well as on the projection screen, connect the computer's monitor cable to the **Monitor Out** connector on the projector.

connect monitor cable

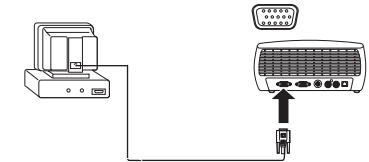

To control your computer's mouse using the projector's remote control, connect the projector to the computer via a USB cable (not included). USB drivers must be installed to use the USB feature. For more information, see page 10.

connect USB cable

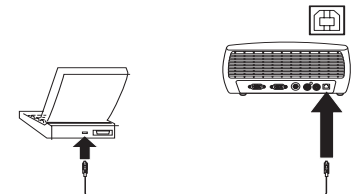

Displaying a computer source image

Remove the lens cap.

remove lens cap

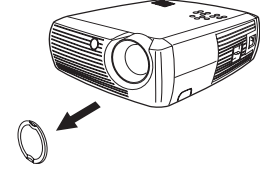

Toggle the **Power** switch on the side of the projector to the On position.

The LED flashes green and the fans start to run. When the lamp comes on, the start up screen displays and the LED is steady green. It can take a minute for the image to achieve full brightness.

toggle Power switch

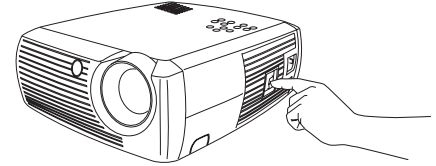

? **No start up screen?** Get help on page 17.

Turn on your computer.

The computer's image should appear on the projection screen. If it doesn't, press the **Computer** button on the projector's keypad.

turn on computer



computer

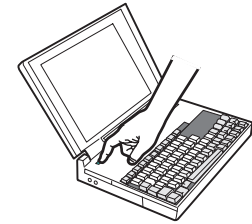

If your computer has Windows 98 as its operating system, see "Using the projector with Windows 98 for the first time" on page 9 regarding the driver setup process.

Make sure your laptop's external video port is active.

Many laptops do not automatically turn on their external video port when a projector is connected. Usually a key combination like FN + F5 is used to turn the external display on and off. Refer to your laptop's documentation to learn your laptop's key combination.

activate laptop's external port

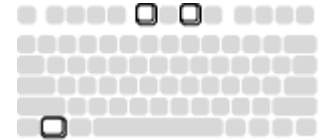

? **No laptop image?** Try pressing the **Auto Image** button on the keypad. Get help on page 18.

Adjusting the image

Adjust the height of the projector, if necessary, by pressing the release button to extend the foot.

Rotate the leveling foot located at the rear of the projector, if necessary.

Avoid placing your hands in near the hot exhaust vent in front of the projector.

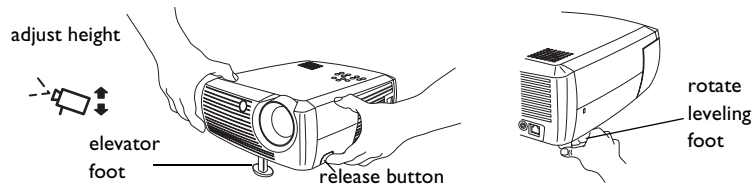

Position the projector the desired distance from the screen at a 90 degree angle to the screen.

See page 40 for a table listing screen sizes and distances.

adjust distance

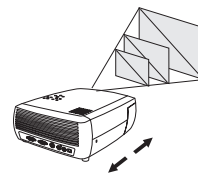

Adjust the zoom or focus.

adjust zoom or focus

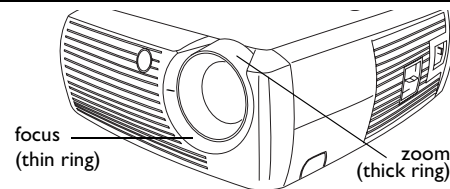

If the image is not square, adjust the keystone using the buttons on the keypad.

Press the top **Keystone** button to reduce the upper part of the image, and press the bottom **Keystone** button to reduce the lower part.

adjust keystone

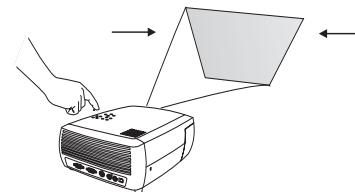

Adjust the Contrast or Brightness in the Picture menu.

See page 30 for help with these menu adjustments.

adjust Picture menu

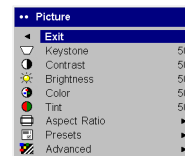

Using the projector with Windows 98 for the first time

The first time you connect a computer running Windows 98 to the projector, the computer recognizes the projector as “new hardware” and the Add New Hardware Wizard appears. Follow these instructions to use the Wizard to load the correct driver (which was installed with your Windows operating system).

If you are running Windows 2000 or Windows ME, skip these steps and go to “Adjusting the image” on page 8.

a Click **Next** to begin searching for the driver.

b Make sure “Search for the best driver” is selected, then click **Next**.

c Uncheck any checked boxes, then click **Next**. Windows automatically locates the driver. If this driver has been removed, reload the driver using your Windows operating system CD.

d When Windows finds the driver, you are ready to install it. Click **Next**.

a



b

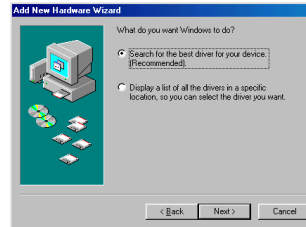

c



d



Skip this page if you did not connect a USB mouse cable

For Windows 98:

- If you connected the USB cable, the Add New Hardware Wizard appears again. Drivers must be installed to use the USB functionality.
- **The Wizard launches three times.**

The first time it detects a USB Composite Device.

The second time a USB Human Interface Device (for the keyboard).

The third time it detects a USB Human Interface Device (for the mouse).

For Windows 2000, Windows ME, and Windows XP:

- The USB drivers are automatically installed.

Connecting a video device

You can connect VCRs, DVD players, camcorders, digital cameras, video games, HDTV receivers, and TV tuners to the projector. There is also an audio input. You can connect the audio directly to the projector to get sound from the onboard speaker, or you can connect it to your stereo's receiver to get sound from your own speakers.

Before connecting your projector, you should decide which aspect ratio you want to use. Aspect ratio is the ratio of the image width to image height. TV screens are usually 4:3, which is the default for this projector. HDTV and most DVDs are 16:9. If you're projecting onto a screen, the size/shape of the screen may answer this question for you. If you are projecting onto a blank wall, you don't have the screen size restriction. What you plan to project will also help you choose between 4:3 and 16:9. Most regular TV shows are 4:3, while most movies are 16:9.

If you select 4:3 and play TV, the image will fill the screen. If you select 16:9 and play HDTV, the image will fill the screen. However, if you select 4:3 and play a 16:9 DVD, the image may be compressed horizontally or have black bars along the top and bottom. If you select 16:9 and play regular TV, the image may be stretched horizontally or have black bars along the sides. You can make this selection later using the onscreen menus (page 30), but for now you just need to know which format you'll use most often.

You can connect the projector to most video devices that can output video. You cannot directly connect the coaxial cable that enters your house from a cable or satellite company, the signal must pass through a tuner first. Examples of tuners are digital cable boxes, VCRs, digital video recorders, and satellite TV boxes. Basically, any device that can change channels is considered a tuner.

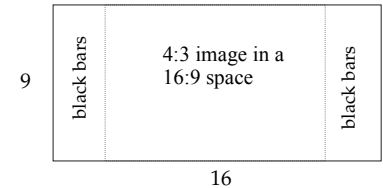
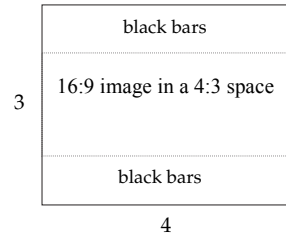

Video connections

The next step is to figure out what type of connectors/output the equipment you want to connect has. If there is more than one output, select the one with the highest quality. Component video has the best quality, followed by S-video, then composite video.

If you are connecting the projector to HDTV, the projector's computer connector should be used.

Keep in mind that HDTV and progressive sources can only be handled through the projector's VGA connector. The optional Component to S-video adapter does not function with progressive sources. With progressive sources, the Component video connector requires the optional Component to VESA adapter.

Here is a list of possible input signals and the connectors they should be connected to on the projector:

Input Signal	Connector	Connector Label on Projector
Standard Broadcast TV (not HDTV), via cable, digital cable, satellite TV, DVD, VCR, DirectTV	Composite video	Video In
	S-video	S-video
	Component Video	S-video (via the optional Component to S-video adapter)
HDTV, Progressive DVD, Progressive Video Game	VGA	Computer In
	Component video	Component Video (via the optional Component to VESA adapter)
Video Camera, Video Game	Composite video	Video In
	S-video	S-video

Video device connections

Composite video connection

Plug the included video cable's yellow connector into the video-out connector on your video device. Plug the other yellow connector into the yellow **Video In** connector on the projector. Plug the included audio adapter's white connector into the left audio out connector on your video device; plug the audio adapter's red connector into the right audio out connector on the video device. Plug the included audio cable into the black connector on the audio adapter. Plug the other end of the audio cable into the blue **Audio In** connector on the projector.

Keep in mind that video output from composite connections are not as high quality as S-video or component.

connect video cable and audio cable (via the audio adapter)

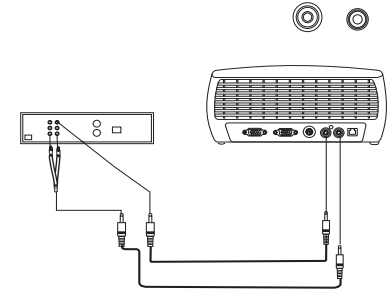

S-video connection

If your video device uses a round, four-prong S-video connector, plug an S-video cable (sold separately) into the S-video connector on your video device and into the **S-video** connector on the projector. Use the audio cable and the audio adapter as described above.

Keep in mind that S-video delivers higher quality video output than composite, but not as high quality video output as component.

connect S-video and audio cable (via audio adapter)

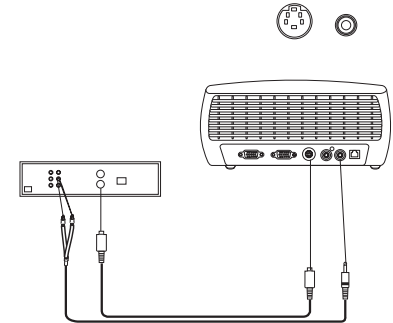

Component video connection

If your video device has component connectors, use a Component to S-video adapter or the Component to VESA adapter (available from a third-party vendor) for HD and progressive sources. Plug the component cable into the video device. Plug the other end of the component cable into the adapter and plug the adapter into the projector's **S-video** (for S-video) or **Computer in** (for VESA) connector. Use the audio adapter as described on the previous page.

Component connection offers the highest quality video output.

connect component cables via component to S-video adapter and audio cables via audio adapter
or
via component to VESA adapter and audio adapter

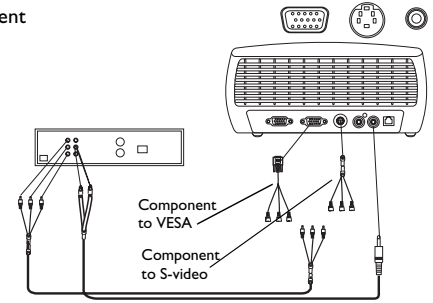

VGA connection

If your video device has a 15-pin VGA output, plug one end of the included computer cable to the VGA connector on your video source. This connector may be labeled "To Monitor" on the video source. Plug the other end of the cable into the **Computer In** connector on the projector.

Use the audio adapter as described on the previous page.

connect VGA cable and audio cable via audio adapter

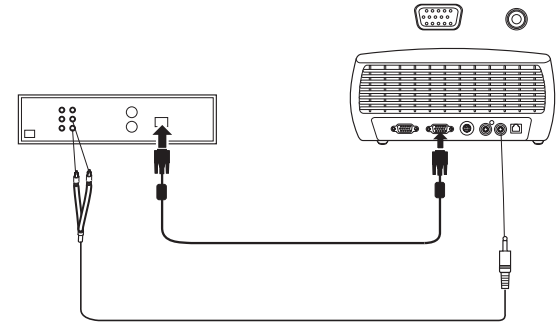

Connect the power cord to the **Power** connector on the side of the projector and to your electrical outlet.

NOTE: Always use the power cord that shipped with the projector.

connect power cable

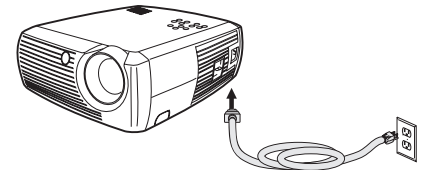

Displaying video

Remove the lens cap.

remove lens cap

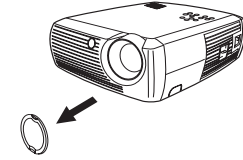

Toggle the **Power** switch on the side of the projector to the **On** position.

The LED flashes green and the fans start to run. When the lamp comes on, the start-up screen is displayed and the LED is steady green. It can take a minute for the image to achieve full brightness.

toggle Power switch

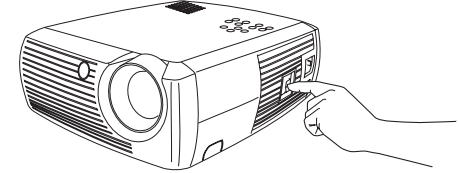

? **No start up screen?** Get help on page 18.

Plug in and turn on your video device.

The video device's image should appear on the projection screen. If it doesn't, press the **Video** button on the keypad.

turn on video device

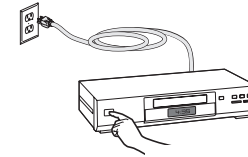

? **No image?** Get help on page 21.

Adjusting the image

Adjust the height of the projector by pressing the release button to extend the foot.

Rotate the leveling foot at the rear of the projector, if necessary.

adjust height



elevator foot

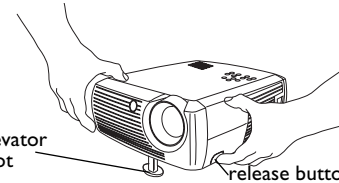

release button

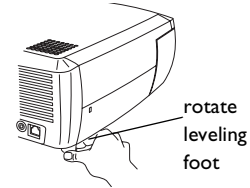

rotate leveling foot

Position the projector the desired distance from the screen at a 90 degree angle to the screen.

See page 40 for a table listing screen sizes and distances to the screen.

adjust distance

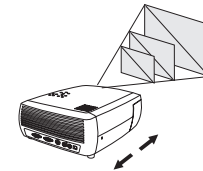

Adjust the zoom and focus.

adjust zoom and focus

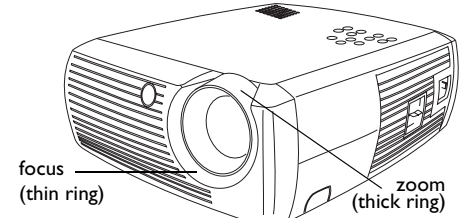

If the image is not square, adjust the keystone using the buttons on the keypad. Press the top **Keystone** button to reduce the upper part of the image, and press the bottom **Keystone** button to reduce the lower part.

adjust keystone

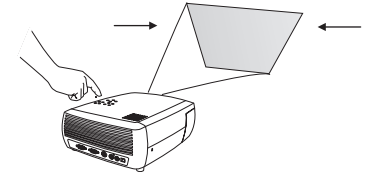

Adjust the volume on the keypad or remote.

adjust volume

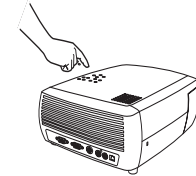

Adjust the Contrast, Brightness, Color, Tint, or Aspect Ratio in the Picture menu. See page 30 for help with the menus and these adjustments.

For Aspect Ratio, keep in mind that DVD players must be configured for 16:9 in order to view the highest quality image. For more information regarding Aspect Ratio, see page 11.

adjust Picture menu options including Aspect Ratio

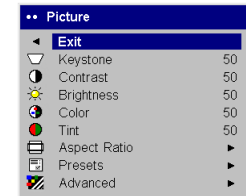

Shutting down the projector

The projector automatically displays a black screen after no active source is detected for 30 minutes. This black screen helps preserve the life of the projector. The image returns when an active source is detected or a remote or keypad button is pressed.

Screen Save

You can make the black screen appear after a preset number of minutes by turning on the Screen Save feature in the **Settings>System** menu. See page 33.

Power Save

The projector also has a Power Save feature that automatically turns the lamp off after no active sources are detected and no user interaction with the projector is performed for 20 minutes. By default, this feature is off. See page 33.

Turning off the projector

You can turn the projector off simply by toggling the power switch to the off position.

You can also press the remote's Power button to place the projector in the Off state while it is running. When the Power button is pressed twice (once to start the power-down process and a second time to verify that you want to power the projector off), the lamp turns off and the LED blinks green for one (1) minute while the fans continue to run to cool the lamp. While the LED is blinking green, the projector does not accept any keypad and remote control input.

When the lamp has cooled, the LED lights solid green and the fans slow down to minimal speed. To turn off the projector, toggle the power switch to the off position.

NOTE: Once the projector has been toggled off, you must wait for one (1) minute before turning the projector on again. This allows the lamp to properly cool. However, if the remote was used to power the projector to the Off state you do not need to wait one minute to turn it on again.

Troubleshooting your setup



If your image appears correctly on the screen, skip to the next section. If it does not, troubleshoot the setup.

The LED on top of the projector indicates the state of the projector and can help you troubleshoot.

Table 1: LED behavior and meaning

LED color/behavior	Meaning
solid green	The power switch has been toggled on and the software has initialized or the projector has been powered off via the remote.
blinking green	The power switch has been toggled on and the software is initializing, or the projector is powering down and the fans are running to cool the lamp.
blinking red see page 41 for more information	A fan or lamp failure has occurred. Make sure the vents aren't blocked (see page 23). Turn off the projector and wait one minute, then turn the projector on again. If the projector has been working for 3,000 hours or more (page 36), replace the lamp and reset the lamp timer. Contact Technical Support if the problem persists.
solid red	An unidentifiable error: please contact Technical Support.

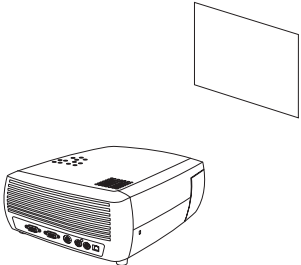
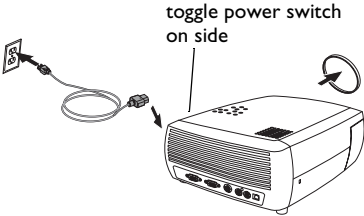
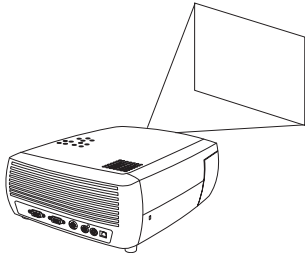
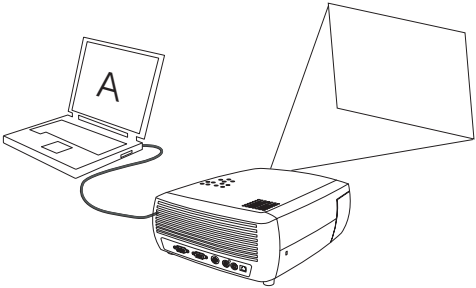
The following tables show common problems. In some cases, more than one possible solution is provided. Try the solutions in the order they are presented. When the problem is solved, you can skip the additional solutions.

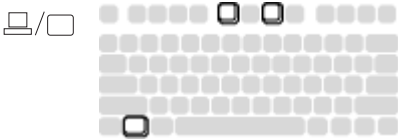
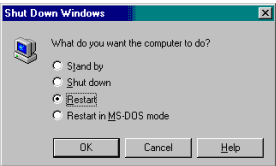
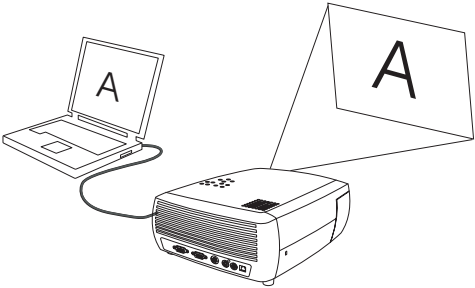
Problem	Solution	Result
<p data-bbox="48 161 262 190">no start up screen</p> 	<p data-bbox="663 156 1100 242">plug power cord in projector's left side remove lens cap toggle power switch</p> 	<p data-bbox="1187 161 1350 190">correct image</p> 
<p data-bbox="48 583 374 611">only start up screen appears</p> 	<p data-bbox="663 575 1008 638">press the Computer button  activate laptop's external port</p>  <p data-bbox="680 833 840 862">restart laptop</p> 	<p data-bbox="1187 583 1494 611">computer image projected</p> 

Problem

no computer image, just the words "Signal out of range"

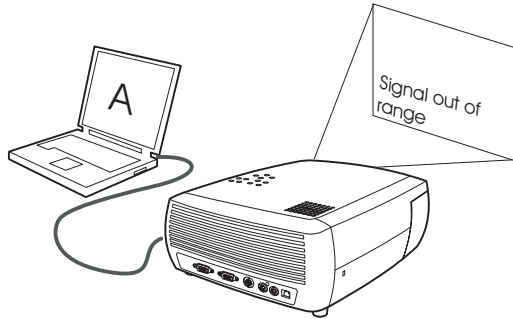

Solution

press the Auto Image button on keypad

auto image



adjust computer refresh rate in Control Panel>Display>Settings>Advanced>Adapter (location varies by operating system)

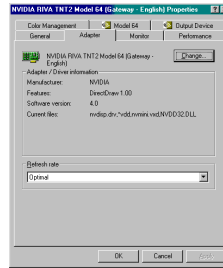







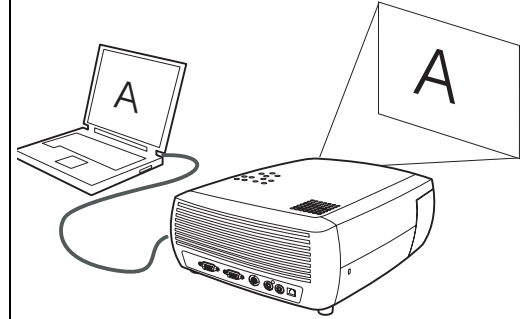

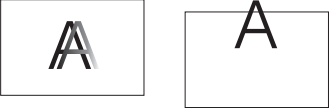
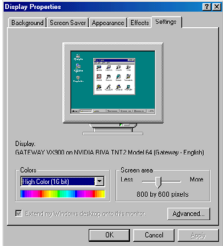
you may also need to set a different resolution on your computer, as shown in the following problem, "image fuzzy or cropped"

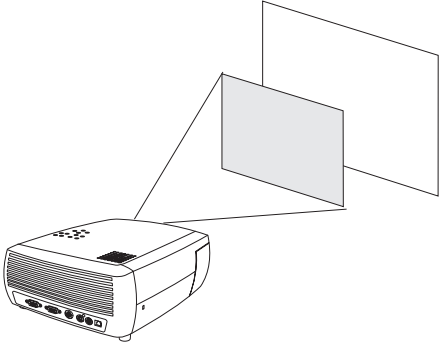
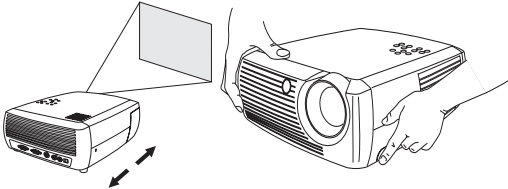
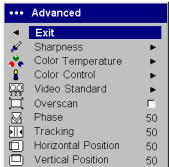
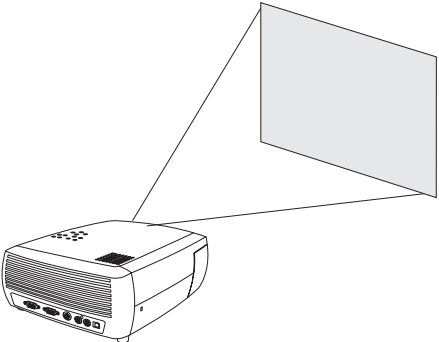



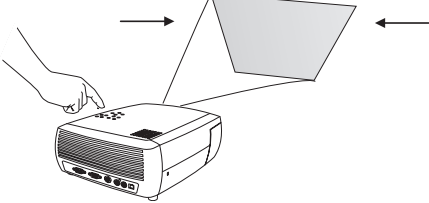

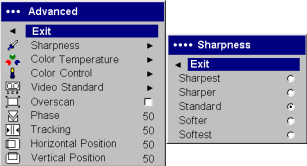

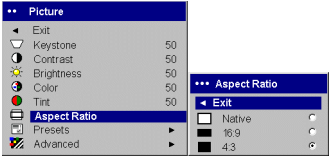
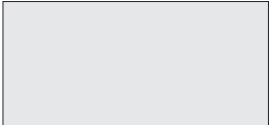
Result

computer image projected

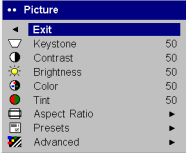

Problem	Solution	Result
<p>image fuzzy or cropped</p> 	<p>set your computer's display resolution to the native resolution of the projector (Start>Settings>Control Panel>Display>Settings tab) select 800x600</p> <p>For a laptop, disable laptop monitor or turn-on dual-display mode</p> 	<p>image clear and not cropped</p> 
<p>image not centered on screen</p> 	<p>move projector, adjust zoom, adjust height</p>  <p>adjust horizontal or vertical position in Picture>Advanced menu</p> 	<p>correct image</p> 

Problem	Solution	Result
<p>image not square</p> 	<p>adjust Keystone on keypad</p> 	<p>square image</p> 
<p>image not sharp</p> 	<p>adjust Sharpness (video sources only) in the Picture>Advanced menu</p> 	<p>correct image</p> 
<p>image does not fit 4:3 or 16:9 screen</p> 	<p>change aspect ratio to 4:3 or 16:9 in Picture>Aspect ratio menu</p> 	<p>correct image</p> 

Problem	Solution	Result
<p>image upside down</p> 	<p>turn off ceiling in Settings>System menu</p> 	<p>correct image</p> 
<p>image reversed left to right</p> 	<p>turn off rear in Settings>System menu</p> 	<p>correct image</p> 
<p>projected colors don't match source</p> 	<p>adjust color, tint, color temperature, brightness, contrast in the menus</p> 	<p>correct image</p> 

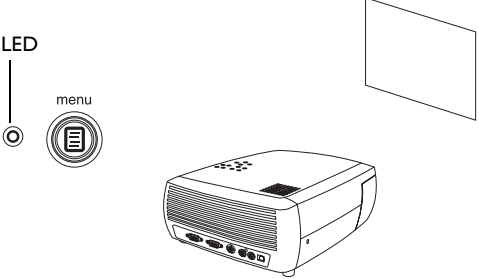
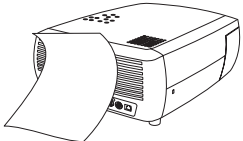
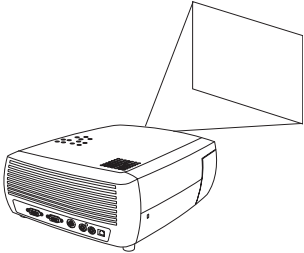
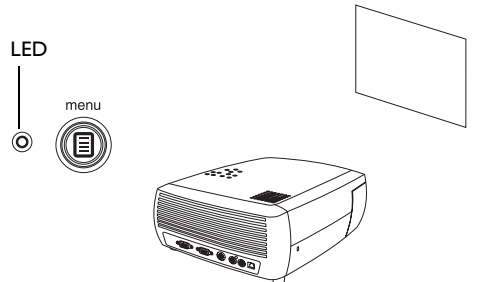
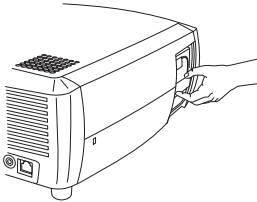
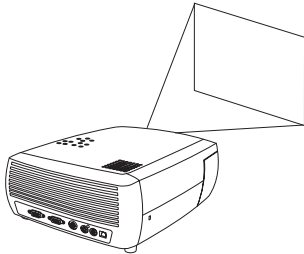
Problem	Solution	Result										
<p data-bbox="48 143 472 169">lamp won't turn on, LED blinking red</p> 	<p data-bbox="663 112 1154 166">make sure vents aren't blocked, turn off the projector and allow it to cool for a minute</p> 	<p data-bbox="1183 143 1350 169">lamp turns on</p> 										
<p data-bbox="48 502 633 556">"Change lamp" message appears at startup or lamp won't turn on and LED blinking red</p> 	<p data-bbox="663 502 1072 556">if lamp hours > 3,000, lamp must be replaced (see page 36)</p> <p data-bbox="663 648 859 702">check lamp hours Main>About</p> <table border="1" data-bbox="911 633 1159 714"> <thead> <tr> <th colspan="2">About</th> </tr> </thead> <tbody> <tr> <td>Lamp Hours Used</td> <td>123</td> </tr> <tr> <td>Active Source</td> <td>Computer 1</td> </tr> <tr> <td>Signal Format</td> <td>1024x768 @ 72Hz</td> </tr> <tr> <td>Version</td> <td>2.1</td> </tr> </tbody> </table> <p data-bbox="933 789 1085 817">replace lamp</p> 	About		Lamp Hours Used	123	Active Source	Computer 1	Signal Format	1024x768 @ 72Hz	Version	2.1	<p data-bbox="1183 502 1350 529">lamp turns on</p> 
About												
Lamp Hours Used	123											
Active Source	Computer 1											
Signal Format	1024x768 @ 72Hz											
Version	2.1											

Still need assistance?

If you need assistance, call Dukane Customer Service directly at **1-800-676-2485**.

Or, send us an e-mail at avserdept@dukane.com

Using the remote control

The remote uses two (2) provided AAA batteries. They are easily installed by sliding the cover off the remote's back, aligning the + and - ends of the batteries, sliding them into place, and then replacing the cover.

Caution: When replacing the batteries, be aware that using batteries other than the type provided with the projector may risk severe damage to the remote. When disposing of the batteries, be sure to do so in an environmentally proper manner.

To operate, point the remote at the projection screen or at the projector (not at the computer). The range of optimum operation is about 15 feet (4.5m).

Pressing the remote's **Power** button when the projector's Power toggle switch is in the Off position does not cause the projector to power up. You need to put the projector's Power toggle switch in the On position to let the remote power on the projector.

When the projector is running, you can press the remote's Power button to place the projector in the Off state (see page 17 for shutdown info) and power it off.

Left and right remote mouse buttons are used to mimic the actions of the left/right mouse buttons on your computer. Mouse cursor movement is managed via the remote's Cursor control. Connect a USB cable to the USB connector on the computer and to the projector to use these buttons and control your computer's mouse. When you do this for the first time, the Add New Hardware wizard may appear. See page 10 for details on loading the correct USB drivers.

Press the remote's **Menu** button to open the projector's menu system. Use the arrow buttons to navigate, and the **Select** button to select features and adjust values in the menus. See page 29 for more info on the menus.

The remote also has **Volume** and **Mute** buttons to control the sound, a **backlight** button to light the remote's buttons in the dark, and **Video** and **Computer** buttons to switch between sources.

Two presentation-specific features are also provided. Use the Blank button to display a blank screen instead of the current slide (you can choose which

color is displayed, see page 34); use the Effect button to invoke a user-definable action, such as freeze, zoom or change your aspect ratio for viewing DVDs (see page 34 to learn to program this button).

If you are displaying presentations in Microsoft® PowerPoint®, you can use the remote's mouse buttons to navigate through your presentation while in Slide Show mode. To configure PowerPoint for this, choose **Options** from the PowerPoint Tools menu, click the **View** tab, de-select the **Popup Menu on Right Mouse Click** option in the Slide Show section, then click **OK**. After that, when you're in PowerPoint's Slide Show mode, a left click advances to the next slide and a right click returns to the previous slide (other PowerPoint modes are not affected).

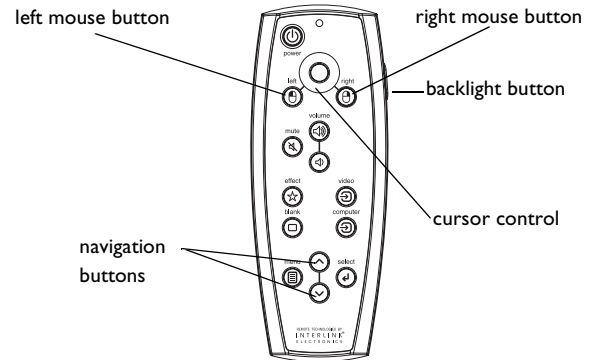

Troubleshooting the remote

- Make sure the batteries are installed in the proper orientation and are not dead.
- Make sure you're pointing the remote at the projector or the screen, not the computer, and are within the remote range of 15 feet (4.5m). For best results, point the remote at the screen.
- If you are trying to control your computer's mouse, make sure the USB cable is connected. If using a USB cable, make sure the correct drivers are installed.

Using the audio

To use the projector's speaker, connect your source to the **Audio In** connector on the projector. See page 13 regarding using the audio adapter.

To adjust the volume, press the **Volume** buttons on the keypad or remote.

To mute the sound, press the **Mute** button on the remote.

Troubleshooting Audio

If you aren't hearing the audio, check the following:

- Make sure the audio cable is connected.
- Make sure mute is not active (press the **Mute** button on the remote).
- Make sure the volume is turned up enough. Press the **Volume** button on the keypad or remote.
- Make sure the correct source is active.
- Adjust the audio source.
- If playing a video, make sure the playback has not been paused.

Using the keypad buttons

Most buttons are described in detail in other sections, but here is an overview of their functions:

Menu—opens the on-screen menus (page 29).

Select—confirms choices made in the menus (page 29).

Up/Down arrows—navigates to and adjusts settings in the menus (page 29).

Auto Image—resets the projector to the source.

Presets—cycles through the available preset settings (page 31).

Keystone—adjusts squareness of the image (page 8).

Volume—adjusts sound (page 26).

Video and **Computer**—changes the active source.

connect audio cable

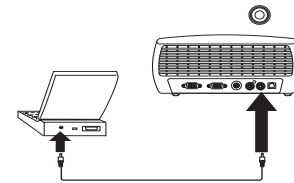

adjust volume

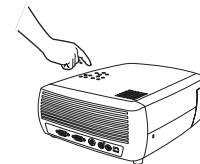

menu navigation buttons

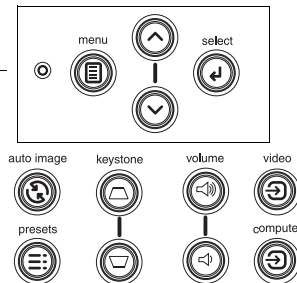

Optimizing computer images

After your computer is connected properly and the computer's image is on the screen, you can optimize the image using the onscreen menus. For general information on using the menus, see page 29.

- Adjust the Keystone, Contrast, or Brightness in the Picture menu (page 30).
- Change the Aspect Ratio. Choose the option that best fits your input source (page 30).
- Adjust the Color Temperature in the Advanced menu (page 32).
- Adjust the phase, Tracking, or Horizontal or Vertical position in the Advanced menu (page 32).
- Once you have optimized the image for a particular source, you can save the settings using Presets. This allows you to quickly recall these settings later (page 31).

Presentation features

Several features are provided to make giving presentations easier. Here is an overview, details are found in the menu section.

- The Effect button on the remote allows you to assign various features to the button. The default effect is About, which displays information about the projector and current source. You can select among Blank, Mute, Aspect Ratio, Source, Auto Image, Freeze, Zoom, and About. See page 34 for details. The freeze effect allows you to freeze the displayed image. This is useful if you want to make changes on your computer without your audience seeing them. The mask effect allows you to cover part of the image with a black curtain.
- The Blank button on the remote allows you to display a blank screen instead of the active source. You can determine the color of this screen (page 34).
- The Startup Logo option lets you change the default start up screen to a blank or default screen (page 34).
- Two options, Power Save and Screen Save, are provided to automatically shut down the projector after several minutes of inactivity or display a black screen. This helps preserve lamp life (page 33).

Optimizing video images

After your video device is connected properly and the image is on the screen, you can optimize the image using the onscreen menus. For general information on using the menus, see page 29.

- Adjust the Keystone, Contrast, Brightness, Color, or Tint in the Picture menu (page 30).
- Change the Aspect Ratio. Choose the option that best fits your input source (page 30).
- The remote's Effect button allows you to assign various features to the button. The default effect is About, which displays information about the projector and current source. You can select among Blank, Mute, Aspect Ratio, Source, Auto Image, Freeze, Zoom, and About. See page 34 for details.
- Select a Sharpness setting (page 32).
- Use the Color Control to adjust the color gain (page 32).
- Adjust the Color Temperature. Select a listed warmth value (page 32).
- Turn on Overscan to remove noise on the edges of the image.

Customizing the projector

You can customize the projector for your specific setup and needs. See page 33 to page 35 for details on these features.

- For rear projection, turn rear mode on in the **Settings>System** menu.
- For ceiling mounted projection, turn ceiling mode on in the **Settings>System** menu.
- Specify which source the projector checks first for active video during power-up.
- Specify the function of the Effect button on the remote.
- Turn the projector's display messages on and off.
- Turn on power saving features.
- Specify blank screen colors and start up logos.
- Specify the language viewed on the menus.
- Save settings for the active source as a preset.

Using the menus

To open the menus, press the **Menu** button on the keypad or remote. (The menus automatically close after 60 seconds if no buttons are pressed.) The Main menu appears. Use the arrow buttons to move up and down to highlight the desired submenu, then press the **Select** button.

To change a menu setting, highlight it, press **Select**, then use the up and down arrow buttons to adjust the value, select an option using radio buttons, or turn the feature on or off using check boxes. Press **Select** to confirm your changes. Use the arrows to navigate to another setting. When your adjustments are complete, navigate to Exit, then press **Select** to go to the previous menu; press the **Menu** button at any time to close the menus.

Dots appears before the menu name. The number of dots indicate menu's level, ranging from one (the Main menu) to four (the most nested menus).

The menus are grouped by usage:

- The Picture menu provides image adjustments.
- The Settings menu provides set-up type adjustments that are not changed often.
- The About menu provides a read-only display of information about the projector and source.

Certain menu items may not be visible or may be grayed depending upon a particular source being connected. For example, Sharpness is only available for video sources and is not visible when a computer source is active. Menu options are grayed out only if the source is selected but no signal is present. For example, if the projector is set to a video source but the source, such as a DVD player, is turned off video menu options are grayed out.

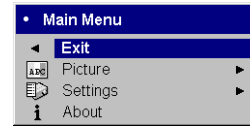

Main menu

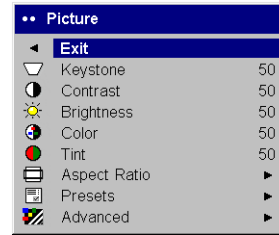
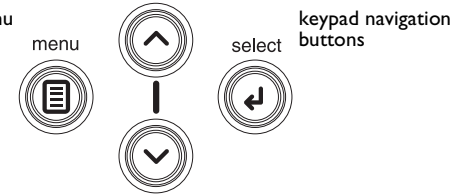

Picture menu

dots

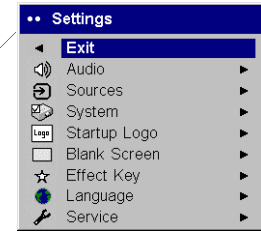

Settings menu

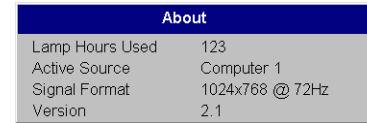

About menu

Picture menu

To adjust the following settings, highlight the setting, press **Select**, use the up and down arrows to adjust the values, then press **Select** to confirm the changes.

Keystone: adjusts the image vertically and makes a squarer image. You can also adjust keystone from the keypad.

Contrast: controls the degree of difference between the lightest and darkest parts of the picture and changes the amount of black and white in the image.

Brightness: changes the intensity of the image.

Color: adjusts a video image from black and white to fully saturated color. The color setting applies to video sources only.

Tint: adjusts the red-green color balance in the image of NTSC video images. The tint setting applies to NTSC video sources only.

Aspect Ratio: Aspect ratio is the ratio of the image width to image height. TV screens are usually 4:3. HDTV and most DVDs are 16:9. The default is 4:3.

Select Native to see the unmodified input with no resizing by the projector.
Select 16:9 to watch enhanced widescreen DVDs.

For more information regarding Aspect Ratio, see page 11.

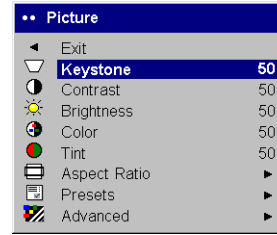

Picture menu

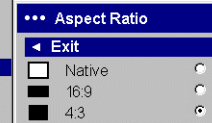
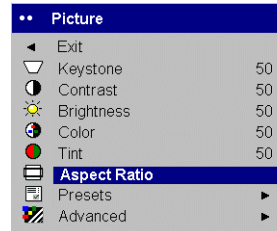
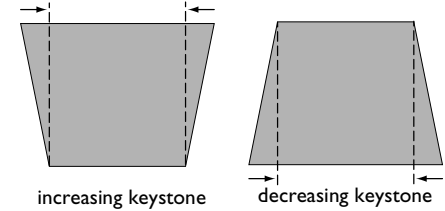

Aspect ratio

Presets: Presets are provided that optimize the projector for displaying computer presentations, photographs, film images, and video images. Film input is material originally captured on a film camera, like a movie; video input is material originally captured on a video camera, like a TV show or sporting event. You can use the preset as a starting point, then further customize the settings for each source. The settings you customize are saved in the preset for each source. To restore the factory default settings, choose Factory Reset in the **Settings>Service** menu (page 35).

There is also a user-definable preset. To set a preset for the current source, adjust the image, select Save User in the Presets menu, then select Yes. You can recall these settings in the future by selecting the User 1 preset.

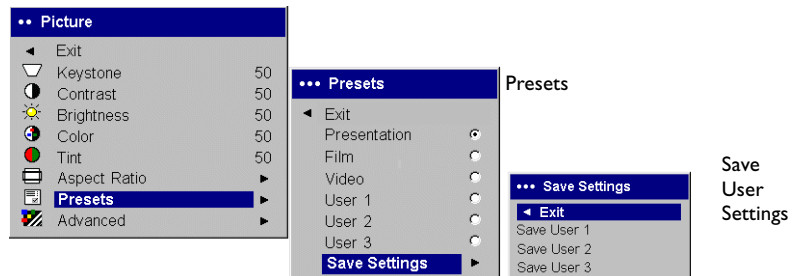

Advanced menu

Sharpness: (video sources only) changes the clarity of the edges of a video image. Select a sharpness setting.

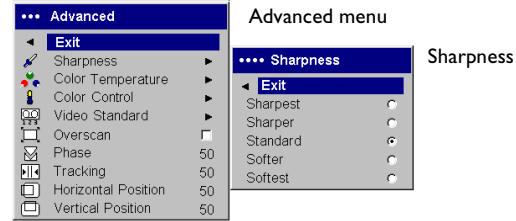

Color Temperature: changes the intensity of the colors. Select a listed relative warmth value.

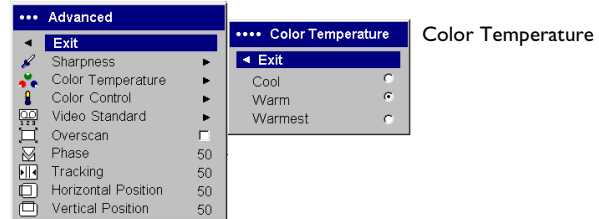

Color Control: allows you to individually adjust the gain for the red, green, and blue colors.

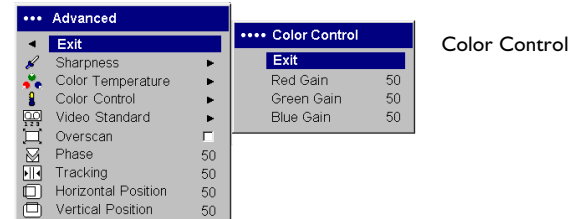

Video Standard: when it is set to Auto, the projector attempts to automatically pick the video standard based on the input signal it receives. (The video standard options may vary depending on your region of the world.) If the projector is unable to detect the correct standard, the colors may not look right or the image may appear “torn.” If this happens, manually select a video standard by selecting NTSC, PAL, or SECAM from the Video Standard menu.

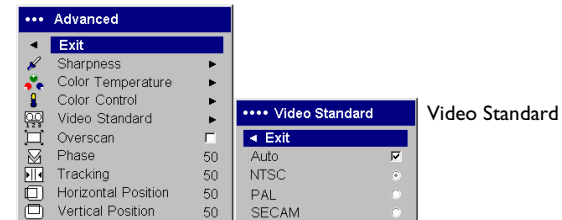

Overscan: (video sources only) removes noise around the video image.

The following four (4) options are for computer sources only.

Phase: adjusts the horizontal phase of a computer source.

Tracking: adjusts the vertical scan of a computer source.

Horizontal/Vertical Position: adjusts the position of a computer source.

Settings menu

Audio: allows adjustments to Volume of the internal speaker. Adjustments can also be made from the projector's keypad and the remote.

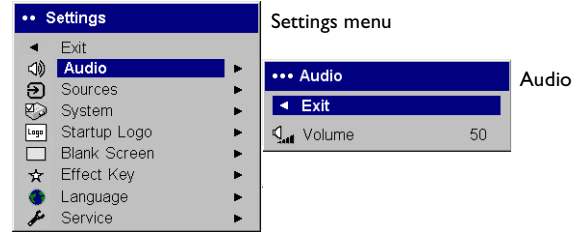

Sources: **Power-up Source** determines which source the projector checks first for active video during power-up. When the **Autosource** feature is On, the projector automatically finds the active source, checking the **Power-up Source** first. The options are Computer 1 for a computer source, and Video 1 (for S-video connections), and Video 2 (for composite video connections) for video sources. When this feature is Off, the projector defaults to the source selected in Power-up Source. To display another source, you must manually select one by pressing the **Computer** or **Video** button on the remote or keypad.

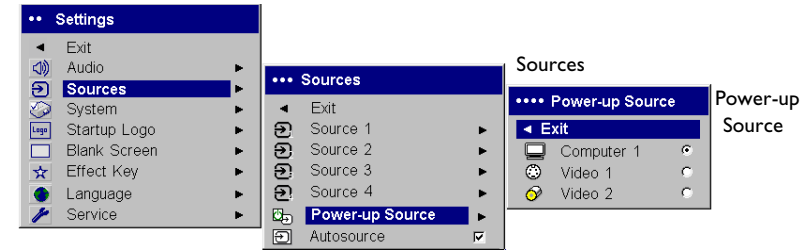

System: **Rear** reverses the image so you can project from behind a translucent screen. **Ceiling** turns the image upside down for ceiling-mounted projection. **Display Messages** displays status messages (such as "Searching" or "Mute") in the lower-left corner of the screen. **NND** prevents your notebook computer from going into Screen Save mode if the USB cable is connected. **Power Save** automatically turns the lamp off after no signals are detected for 20 minutes. After an additional 10 minutes with no signal, the projector powers down and can be toggled off. If an active signal is received before the projector powers down, the image will be displayed. When Power Save is enabled, Screen Save is disabled. **Screen Save** automatically blanks the screen with a black color after no signals are detected for a preset number of minutes. The image returns when an active source is detected or a remote or keypad button is pressed.

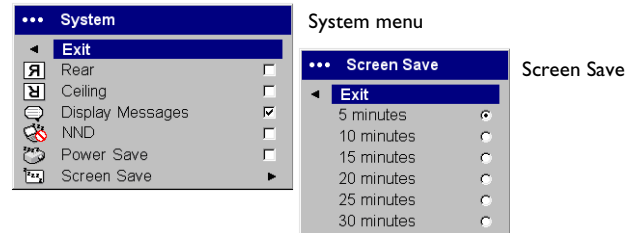

Startup Logo: allows you to display a blank screen instead of the default screen at startup, and when no source is detected.

Blank Screen: determines what color is displayed when you press the Blank button on the remote.

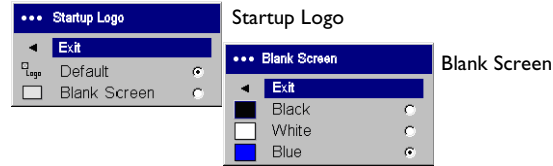

Effect Key: allows you to assign a different function to the Effect button on the remote, allowing you to quickly and easily use the effect. Highlight an effect and press **Select** to choose a different one.

- **Blank:** displays an empty screen.
- **Mute:** turns off all sound.
- **Aspect Ratio:** toggles among 4:3, 16:9, and Native (see page 11 and page 30). Set as the Effect Key, it can allow you to switch the Aspect Ratio for DVDs.
- **Source:** cycles through available sources.
- **Auto Image:** resets the projector to the source (page 26).
- **Freeze:** pauses the projected image.
- **Zoom:** allows you to magnify part of the image. Press **Effect**, then press the left mouse button to zoom the image. Use the cursor control to pan the image while it is zoomed. Press the right mouse button to decrease the magnification. Press the **Effect** button to cancel zoom and return to normal magnification.
- **About:** the default effect. It opens a window with projector and source information.

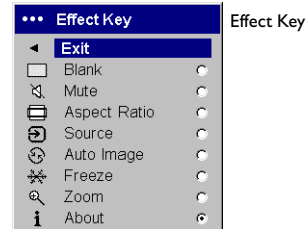

Language: allows you to select a language for the onscreen display.



Language menu

Service: To use these features, highlight them and press **Select**.

Factory Reset: restores all settings to their default.

Lamp Reset: resets the lamp hours used counter in the About menu to zero. Do this only after changing the lamp.

Service Code: only used by authorized service personnel.

About: provides information about the projector and the active source. Showing the About box is the default action assigned to the Effect button.

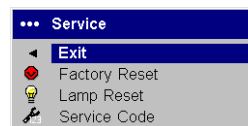

Service menu

About	
Lamp Hours Used	123
Active Source	Computer 1
Signal Format	1024x768 @ 72Hz
Version	2.1

About menu

Maintenance

Cleaning the Lens

- 1 Apply a non-abrasive camera lens cleaner to a soft, dry cloth.
 - Avoid using an excessive amount of cleaner, and don't apply the cleaner directly to the lens. Abrasive cleaners, solvents or other harsh chemicals might scratch the lens.
- 2 Lightly wipe the cleaning cloth over the lens in a circular motion. If you don't intend to use the projector immediately, replace the lens cap.

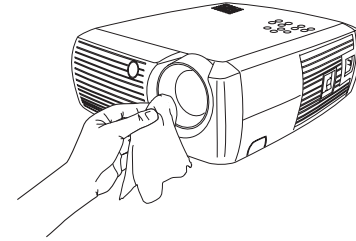

Replacing the Projection Lamp

The lamp hours used timer in the About menu counts the number of hours the lamp has been in use. After 2,980 hours, the message “Change lamp” appears on the screen at startup. If the maximum lamp time of 3,000 hours is exceeded, the lamp will not light. In this case, after replacing the lamp you must reset the lamp hours by simultaneously pressing both **Volume** buttons on the keypad and holding them for 10 seconds.

NOTE: You can order new lamp housings from your dealer.

- 1 Turn off the projector and unplug the power cord.
- 2 Wait 30 minutes to allow the projector to cool thoroughly.
- 3 Turn the projector on its side so that the lamp door is facing you. Using a flat-blade screwdriver, gently pry the lamp door from the projector by placing the screwdriver blade into the space between the top of the lamp door and the projector.

About	
Lamp Hours Used	123
Active Source	Computer 1
Signal Format	1024x768 @ 72Hz
Version	2.1

Lamp hours used

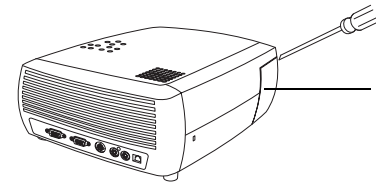
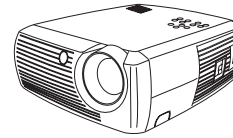

- Loosen the two captive screws that attach the lamp housing to the projector.
- Detach the lamp connector from the projector by depressing the locking tab on the connector and lightly pulling it free.

WARNING:

To avoid burns, allow the projector to cool for at least 30 minutes before you replace the lamp.

Do not drop the lamp housing or touch the glass bulb! The glass may shatter and cause injury.

Be extremely careful when removing the lamp housing. In the unlikely event that the bulb ruptures, small glass fragments may be generated. The lamp housing is designed to contain these fragments, but use caution when removing the lamp housing.

- Carefully remove the lamp housing. Dispose of the lamp in an environmentally proper manner.
- Install the new lamp housing and tighten the screws.
- Re-attach the lamp connector to the projector. The locking tab should engage when the connector is fully plugged in.
- Replace the lamp door.
- Plug in the power cord and toggle the **Power** switch to turn the projector back on.
- To reset the lamp hour timer, navigate to the **Settings>Service** menu and select **Lamp Reset**. See page 35 for details.

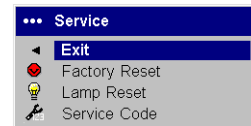
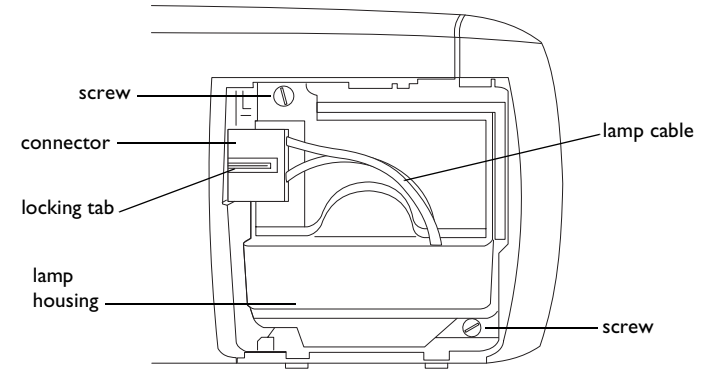
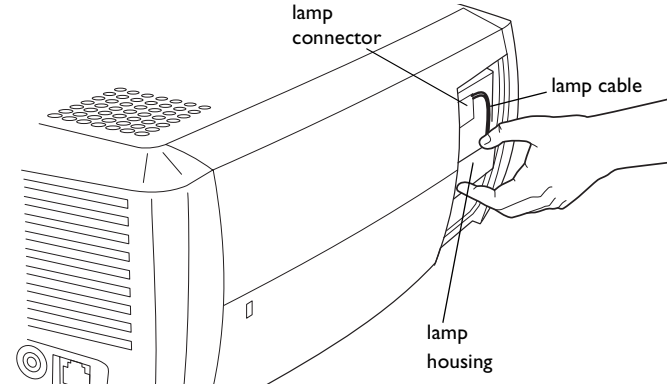

Service menu

Cleaning the Lamp Housing Screens

In dirty or dusty environments, the two dust filter screens in the lamp housing can become clogged, causing high temperatures and premature lamp failure. Routine maintenance to remove dust from the screens lowers the lamp operating temperature and prolongs lamp life. To maximize lamp life you should clean the screen every 250 hours.

- 1 Remove the lamp housing.
- 2 Examine the dust filter screens on the lamp housing. If necessary, use a vacuum cleaner set on low power to clean the screens. Be careful not to disturb any internal components when cleaning the screens.
- 3 Replace the lamp housing and lamp door.

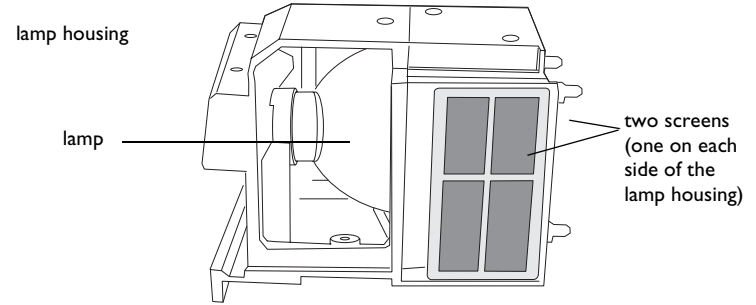

Using the security lock

The projector has a security lock for use with a PC Guardian Cable Lock System

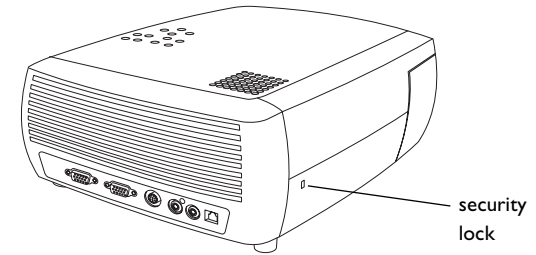

Appendix

Specifications

Temperature	50 to 104° F (10 to 40° C) at sea level
Operating	50 to 95° F (10 to 35° C) at 10,000 feet
Non-operating	-4 to 140° F (-20 to 60° C)

Altitude	0 to 10,000 feet (3,048 meters)
Operating	0 to 10,000 feet (3,048 meters)
Non-operating	0 to 20,000 feet (6,096 meters)

Humidity	10% to 95% relative humidity, non-condensing
Operating	10% to 95% relative humidity, non-condensing
Non-operating	10% to 90% relative humidity, non-condensing

Dimensions	12.5 x 9.8 x 4.49" (318 x 249 x 114 mm)
-------------------	---

Weight	6.8 lbs. (3.1 kg) unpacked
---------------	----------------------------

Optics Focus Range	4.9 - 32.8 feet (1.5 - 10 m)
---------------------------	------------------------------

Lamp type	150 - W DC SHP lamp
------------------	---------------------

Input Power Requirements	100-120/200-240 3/2A 50/60Hz
---------------------------------	------------------------------

Ceiling Mount	UL tested/listed ceiling mount with minimum capacity of 34 lbs (15.5 kg)
----------------------	--

Projected image size

Table 2:

Range of distance to the screen for a given screen size for the InFocus X1

Diagonal Screen Size (inches/m)	Image Width (inches/m)	Distance to screen	
		Maximum distance (feet/m)	Minimum Distance (feet/m)
40/1	32/0.8	5.8/1.8	4.8/1.5
50/1.3	40/1	7.8/2.4	6.5/2.0
60/1.5	48/1.2	8.8/2.7	7.5/2.3
100/2.5	80/2	14.6/4.5	12.4/3.8
150/3.8	120/3.1	22.6/6.9	19.03/5.8
200/5.1	160/4.1	30.5/9.3	25.2/7.7

Red LED Behavior and Projector Errors

If the projector is not functioning properly and the LED is blinking red, consult **Table 3** to determine a possible cause. There are two-second pauses between the blinking cycles.

Table 3:

Red LED Behavior	Explanation
One (1) blink	The lamp won't strike after five (5) attempts. Check the lamp and lamp door installations for loose connections.
Two (2) blinks	The lamp counter hours have exceeded lamp life hours. Replace the lamp and reset the lamp hours counter.
Three (3) blinks	The projector has shut down. Check to see if the lamp door is open. If the lamp door is closed, toggle off the projector and wait one minute, then toggle the projector on again. If the lamp does not strike after one minute, replace the lamp. Contact Technical Support (see page 24) for repair if replacing the lamp does not solve the problem.
Four (4) blinks	The fan has failed. Contact Technical Support (see page 24) for repair or replacing the fan.
Five (5) blinks	The projector is overheating. Check for a blocked air vent. Contact Technical Support (see page 24) for repair if clearing the air vents does not solve the problem.

Numerics

16x9 vs 4x3 screen aspect 11
800x600 resolution 4

A

About 34, 35

Advance menu 32

altitude limits 39

Aspect Ratio 34

Aspect ratio 30

aspect ratio 11

Audio 33

Audio In connector 6, 13, 26

Autosource 33

B

Blank button 27

Blank Screen 34

blinking green 17

blinking red 17

Brightness 30

C

cable box 11

Ceiling 33

Color 30

Color Temperature 32

compatibility

 IBM-compatible 4

 Macintosh 4

 video devices 4

component cable connector 14

Computer In connector 6

connecting

 video device 11

connectors on module 12

Contrast 30

Customer Service 24

customer service contact information 24

customizing the projector 28

D

Display Messages 33

Drivers

 USB 10

 Windows 98 10

DVDs 30

E

Effect button 27

Effect Key 34

e-mail

 technical support 24

F

Factory Reset 35

focus 8, 16

H

HDTV 4, 30

Horizontal 32

I

IBM-compatible computers 4

image

 size 5

image optimization 27

image size

 projected 40

K

- keypad buttons
 - projector 26
- keystone adjustment 8, 16

L

- Lamp Housing Screens
 - cleaning 38
- lamp replacement 36
- Lamp Reset 35
- Language 35
- LED 17
 - blinking green 17
 - solid green 17
- LED Behavior
 - red 41
- LED behavior 17
- lens
 - cap 39
- leveling foot 15

M

- Macintosh computers
 - compatibility 4
- maintaining the projector 36
- Menu button 29
- menu usage 29
- Monitor Out connector 6
- mouse, using your 6
- Mute button 26

N

- NND 33
- O**
- optimizing images 27
- optimizing video 28
- Overscan 32

P

- Phase 32
- phone numbers
 - technical support 24
- Picture menu 30
- Power connector 6
- power cord 6, 14
- Power Save 17
- Power switch 7
- PowerPoint
 - remote's mouse buttons 25
- Power-up Source 33
- presentation
 - features 27
- Presets 31
- projection distance 5
- projector
 - connecting video devices 11
 - customization 28
 - keypad buttons 26
 - maintenance 36
 - positioning 5
 - returning for service 24
 - setting up 5
 - troubleshooting problems 17
 - turning off 17

R

- Rear 33
- Red LED behavior 41
- remote control
 - usage 25
- replacing the lamp 36

S

Screen Aspect 11
Screen Save 17
security lock 38
Service 35
Service Code 35
Settings menu 33
sharpness 32
solid green 17
solid red 17
Sources 33
Specifications 39
Startup Logo 34
S-video connector 13
System 33

T

technical support
 e-mail 24
 phone numbers 24
temperature limits 39
Tint 30
Tracking 32
troubleshooting 17
turning off
 projector 17
TV tuner 11

U

USB 6
USB, using your mouse 6

V

vents 3
Vertical 32
Video In connector 13
video optimizing 28
Video Standard 32
volume adjustment 16

Volume button 26

W

Windows 2000 10
Windows 98 9
Windows ME 10
Windows XP 10

Z

zoom 8, 16

LEGAL INFORMATION

FIVE-YEAR LIMITED WARRANTY

This Dukane LCD projector is warranted to the original purchaser for a period of five (5) years from the original purchase date - in normal use and service - against defects in material and workmanship. **DUKANE CORPORATION EXPRESSLY DISCLAIMS ALL OTHER WARRANTIES OF MERCHANTABILITY AND FITNESS FOR A PARTICULAR PURPOSE.**

During the warranty period, Dukane Corporation will repair or replace (at the manufacturer's option) any such defective parts (except for the lamp, which is subject to whatever warranties the manufacturer may provide) without charge to the purchaser for parts or labor when the product is returned, prepaid and insured, with proof-of-purchase date. This remedy is void if the product has been damaged by accident, unreasonable use, neglect, improper service or other causes not arising out of defects in material or workmanship.

Dukane Corporation disclaims all liability for incidental or consequential damage of any kind, including all damages arising out of any interruptions in operation of the product and all damages to software.

No person, firm, or representative is authorized to assume any obligation or to make any warranty on behalf of the Dukane Corporation other than as stated above.

**THIS LIMITED WARRANTY IS VALID FOR U.S.A AND CANADA.
FOR OTHER LOCATIONS, LOCAL WARRANTIES APPLY.**

LAMP REPLACEMENT SERVICE & REPAIR POLICY & PROCEDURE

For service and parts, contact the Dukane AV Service Department at 1 (800) 676-2487 within the USA or 1 (630) 584-2300 worldwide. If you would like to send a facsimile (FAX), dial 1 (630) 584-5156 worldwide.

When requesting warranty service, please have the sales receipt available along with the model name and serial number.

If it becomes necessary to return the projector, use the original packing material and box (if retained) or pack securely. Dukane Corporation will not be liable for any pick-up or delivery charges or any expenses incurred for service calls or service supplied by anyone other than the Dukane AV Service Department.

Dukane Corporation
Audio Visual Products Division
2900 Dukane Drive
St. Charles, IL 60174-3395
E-mail: avsales@dukane.com

Phone: (630) 584-2300
Orders: (800) 676-2485
Information: (800) 676-2486
Fax: (630) 584-5156
Parts & Service: (800) 676-2487
Fax: (630) 584-0984

Audio Visual Products

DUKANE

Part # 401-599-00